

EXHIBITOR SERVICE MANUAL



PPPC

FEBRUARY 27, 2025

VANCOUVER CONVENTION CENTRE





PPPC TOPS

FEBRUARY 27, 2025
VANCOUVER CONVENTION CENTRE

Dear Exhibitor,

Together with show management we have compiled this Exhibitor Services Manual with the hopes of providing you with all of the necessary information and service order forms that you will need for a successful conference experience.

If you have any questions regarding any of our services, have any requirements not detailed in this service manual or need any assistance with planning your exhibit, please do not hesitate to contact us using the information provided on enclosed Contact Info & Quick Facts form.

We are here to answer all of your questions, provide you with all of your display needs and ensure that your participation in this conference is successful and hassle free.

Each exhibit booth will be supplied with the following courtesy of show management;

- 8' high drape back wall
- 4' high drape side wings
- 1 paper identification booth number

The Vancouver Convention Centre enforces a strict ban on direct to show shipments and will not accept any shipments of exhibit materials. Shipments direct to show site will be refused. All exhibit material, regardless of size or description, must be shipped to the address shown on the attached shipping label. We will receive your exhibit materials beginning February 5 and all materials will be delivered and waiting for you upon arrival at your booth

In order to qualify for discount prices please take time to review this manual thoroughly. To receive discount pricing your order, along with payment in full must be received by the date indicated on each form.

We realize that exhibiting in a trade show can be complicated. Please do not hesitate to call us with any questions or concerns.

We look forward to being of service to you at this event.

21 - 8528 - 123 STREET
SURREY BC
CANADA - V3W 3V6

PHONE 604 599 1440
FAX 604 599 1438

324 WESTMINSTER AVENUE WEST
PENTICTON BC
CANADA - V2A 1K2

PHONE 236 422 1440
FAX 236 422 1438

www.showinmotion.com



TELEPHONE: (236) 422-1440
FACSIMILE: (236) 422-1438

**CONTACT INFO
AND QUICK FACTS**



HOW TO REACH US

- TELEPHONE - (236) 422-1440
- FACSIMILE - (236) 422-1438

For General & Rental Inquiries Please Contact
Jaclyn Klassen (Orders@showinmotion.com)

For Specific Shipping Inquiries Please Contact
Brian Huggan (Brian@showinmotion.com)

For Specific Electrical Inquiries Please Contact
Vancouver Convention Centre 604-689-6282

MOVE IN / MOVE OUT & SHOW HOURS

Exhibitor Move In:	Wednesday, February 26, 2025 Time: 2:00 PM - 7:00 PM
Exhibit Hours:	Thursday, February 27, 2025 Time: 9:00 AM - 3:00 PM
Exhibitor Move Out:	Thursday, February 27, 2025 Time: 4:00 PM - 8:00 PM

EXHIBIT SHIPPING ADDRESS

“Your Company Name”
PPPC TOPS
c/o # 21 - 8528 - 123 Street
Surrey, BC, V3W 3V6
Canada



TELEPHONE: (236) 422-1440
FACSIMILE: (236) 422-1438

CREDIT CARD AUTHORIZATION



IF YOU ARE USING THE SERVICES OF SHOW IN MOTION, THIS FORM MUST BE COMPLETED AND RETURNED TOGETHER WITH A PHOTOCOPY OF THE FRONT OF THE CREDIT CARD BEING PROVIDED.
NO ORDERS WILL BE ACCEPTED UNLESS ALL INFORMATION IS PROVIDED.

BY SIGNING THIS FORM YOU AGREE THAT YOUR ORDER WILL BE GOVERNED AND BOUND BY BOTH THE SHOW IN MOTION PAYMENT POLICY AND TERMS AND CONDITIONS OF CONTRACT AS SPECIFIED IN THE EXHIBITOR MANUAL AND HAVE ADVISED YOUR SHOW SITE REPRESENTATIVE(S) ACCORDINGLY. YOU ARE ENTERING INTO A CONTRACT. PLEASE READ THESE DOCUMENTS THOROUGHLY.

WE WILL USE THIS AUTHORIZATION TO CHARGE YOUR CREDIT CARD ACCOUNT FOR YOUR INITIAL ORDER AND ANY ADDITIONAL AMOUNTS INCURRED AS A RESULT OF SHOWSITE ORDERS PLACED BY YOU OR YOUR REPRESENTATIVE OR SERVICES RENDERED TO YOUR COMPANY AT THIS EVENT. THESE CHARGES MAY INCLUDE LABOR, MATERIALS HANDLING OR ANY CHARGES WHICH SHOW IN MOTION MAY BE OBLIGATED TO PAY ON YOUR BEHALF INCLUDING, WITHOUT LIMITATION, ANY SHIPPING CHARGES.

WE RESERVE THE RIGHT TO ADJUST ORDERS NOT CALCULATED CORRECTLY. THESE CORRECTIONS MAY INCLUDE MATERIALS HANDLING CALCULATIONS AND POST DEADLINE PRICING.

THIS COMPLETED FORM MUST ACCOMPANY ALL OTHER COMPLETED SERVICE REQUEST FORMS.

COMPANY: _____ BOOTH #: _____
ADDRESS: _____ PHONE #: _____
CITY & PROVINCE: _____ FAX #: _____
POSTAL / ZIP CODE: _____ EMAIL: _____

PLEASE COMPLETE CLEARLY THE FOLLOWING INFORMATION;

MASTERCARD VISA AMERICAN EXPRESS

ACCOUNT NUMBER

EXPIRATION DATE : _____ CCV CODE : _____

I, _____ of _____ do
(Cardholder name) (Exhibiting Company)

hereby authorize Show In Motion Services, Inc. to charge my credit card for expenses related to the above named event. I agree that in placing this order I have accepted Show In Motions' Payment Policy and Terms & Conditions of Contract. I acknowledge that my calculations for materials handling, labor and outbound freight are estimates only and understand that the total amount of the charges to my credit card is subject to final verification by Show In Motion at the conclusion of the event allowing for my estimation of labor and / or materials handling charges and / or pre-show discounts. I further understand and agree that, as the representative for the exhibiting company, I am ultimately responsible for payment of all charges and agree to be bound by all terms and conditions as described on this form and the Payment Policy Form.

BILLING ADDRESS: _____

CARDHOLDERS SIGNATURE: _____

YOUR SIGNATURE DENOTES ACCEPTANCE OF ALL TERMS & CONDITIONS INCLUDED IN THIS SERVICE MANUAL.



TELEPHONE: (236) 422-1440
FACSIMILE: (236) 422-1438

SHIPPING INSTRUCTIONS AND ADDRESS



THE VANCOUVER CONVENTION CENTRE ADHERES TO A STRICT NO SHIPMENTS POLICY AND DOES NOT ALLOW DIRECT TO SHOW SHIPMENTS OF ANY KIND. ALL EXHIBIT MATERIALS MUST BE SHIPPED TO THE ADDRESS SHOWN BELOW.

SHIPMENTS MAY BE SENT TO THE ADVANCE WAREHOUSE BEGINNING WEDNESDAY, FEBRUARY 5.

SHIPMENTS ARRIVING AFTER MONDAY, FEBRUARY 17 WILL NOT BE ELIGIBLE FOR PRE-SHOW DISCOUNTS.

PLEASE ENSURE YOUR MATERIALS ARRIVE NO LATER THAN FRIDAY, FEBRUARY 21 TO
AVOID POTENTIAL DELAYS AND OFF TARGET DESIGNATION.

PLEASE ENSURE THAT ALL MATERIALS SHIPPED TO THIS EVENT ARE PROPERLY BOXED, PADDED AND /
OR SHRINK WRAPPED TO A PALLET IN ORDER TO AVOID ADDITIONAL HANDLING CHARGES.

ALL MATERIAL HANDLING SERVICES PROVIDED BY SHOW IN MOTION ARE IN ACCORDANCE WITH THE
CONDITIONS SPECIFIED ON THE ATTACHED MATERIALS HANDLING AND TERMS & CONDITIONS FORMS.

IT IS THE RESPONSIBILITY OF THE EXHIBITOR TO MAKE RETURN SHIPPING ARRANGEMENTS WITH THE
PREFERRED CARRIER OF THEIR CHOICE.

ALL OUTBOUND FREIGHT MUST BE SHIPPED DIRECTLY FROM SHOW SITE IMMEDIATELY FOLLOWING
THE CLOSE OF SHOW UNLESS POST SHOW FREIGHT AND STORAGE SERVICES HAVE BEEN ORDERED
THROUGH SHOW IN MOTION.

YOUR COMPLETED MATERIALS HANDLING AND CREDIT CARD AUTHORIZATION FORMS MUST BE SENT
TO SHOW IN MOTION.

MATERIALS HANDLING SERVICES INCLUDES THE FOLLOWING;

- ADVANCE RECEIVING YOUR MATERIALS BEGINNING FEBRUARY 5.
- DELIVERING YOUR MATERIAL TO SHOW SITE.
- PLACEMENT OF YOUR EXHIBIT MATERIAL IN YOUR BOOTH (SUBJECT TO FACILITY RESTRICTIONS).
- REMOVAL OF EMPTY CRATES AND BOXES FOR STORAGE DURING EXHIBIT HOURS.
- RETURN OF EMPTY CRATES AND BOXES AT CLOSE OF SHOW.
- LOADING OF YOUR MATERIAL ON TO DESIGNATED TRUCK FOR RE-SHIPMENT.

PLEASE REMOVE ALL OLD LABELS AND ENSURE THAT ALL FREIGHT DESTINED FOR THIS EVENT IS
LABELED WITH THE FOLLOWING INFORMATION. USE ATTACHED SHIPPING LABEL TO AVOID
ADDITIONAL CHARGES AND DELAYS.

**PPPC TOPS
c/o SHOW IN MOTION
21 - 8528 - 123 STREET
SURREY, BC, V3W 3V6**



TELEPHONE: (236) 422-1440
FACSIMILE: (236) 422-1438

PRE & POST SHOW STORAGE FAQ'S



SHIPMENTS OF EXHIBIT MATERIALS, OF ANY SIZE OR DESCRIPTION, DIRECT TO SHOW SITE ARE NOT PERMITTED AND WILL BE REFUSED. ALL EXHIBIT MATERIALS MUST BE SENT TO THE ADDRESS SHOWN ON THE ATTACHED SHIPPING LABEL.

UNLESS POST SHOW MATERIALS HANDLING SERVICE IS ORDERED, YOUR EXHIBIT MATERIALS MUST BE REMOVED FROM THE EXHIBIT FLOOR BY THE TIME AND DATE INDICATED ON THE ATTACHED POST SHOW MATERIALS HANDLING & STORAGE ORDER FORM.

PRE-SHOW SHIPMENTS

What information do I need to place an order?

- To place your order you should provide us with;
 - The number of pieces in your shipment
 - The dimensions of each piece
 - Your Carrier's name
 - The tracking number(s) for your shipment
 - Your completed Materials Handling Order form
 - Your completed Credit Card Authorization form.

What if I don't know all of the details of my shipment?

- Place your order with the information that you have now and update us once you know more. For example, if you don't know the exact number of pieces you will be shipping, please provide your best estimate. We will update your order once your shipment has been received at our warehouse.

Why do you need my Carrier's info and tracking number?

- Having this information will help us track and locate your shipment if it delayed and to alert you.

When can I send my exhibit materials to you?

- You may send your materials to us beginning 30 days prior to the exhibit date of your event.

What happens if my shipment arrives before the deadlines?

- We understand the time sensitive nature of the industry. We will receive your exhibit materials whenever they arrive (even after move in has begun) and will deliver your shipment to your booth as quickly as possible. However, additional charges may be incurred if additional services are necessary.

What happens to my shipment once it is delivered to you?

- Your shipment will be received, weighed and placed in to secure storage. On the day of move-in your materials will be removed from storage, transported to show site and delivered right to your booth.

POST-SHOW SHIPMENTS

What information do I need to use your Post Show Materials Handling & Storage services?

- To place your order we will require;
 - Completed waybill from your carrier
 - Address labels (you may get these from the Exhibitor Service Center in the exhibit hall.
 - Customs documents if required for International shipment
 - Your completed Post Show Materials Handling Order form.

What do I need to do during move-out?

- Ensure that you have attached your carriers BOL's to each piece in your shipment.
- If carrier BOL's are not available during teardown please email these to Brad@showinmotion.com
- A Show In Motion representative will connect with you before the show ends to confirm your instructions.
- Empty boxes and crates (if removed for storage) will be returned to your booth.
- Pack up your materials for return shipment. If supplies are needed you may get these from the Exhibitor Service Center.
- Ensure that each piece of your shipment has been labeled to the final destination.
- Schedule your shipment for pick up by your Carrier
- Leave your materials in your booth location.

What will happen to my shipment after Exhibitor move-out?

- Your shipment will be collected from your booth and loaded on to our truck for delivery back to the advance warehouse.
- Once back at our warehouse your shipment will be weighed and sorted.
- When your Carrier arrives your shipment will be loaded on to your Carrier's truck for return shipment to you.

When can my shipment be picked up?

- Your shipment may be picked up any time after noon on the first business day after Exhibitor move-out.

**PRE-SHOW SHIPPING
& STORAGE LABEL**

**EXHIBIT MATERIAL
DO NOT DELAY
RUSH !**

**EXHIBITING
COMPANY:**

SHIP TO: C/O SHOW IN MOTION
21 - 8528 - 123 STREET
SURREY, BC, CANADA
V3W 3V6
(TEL) 236-422-1440
(FAX) 236-422-1438

RE: PPPC TOPS

BOOTH # : _____

CARRIER : _____

NUMBER _____ OF _____



TELEPHONE: (236) 422-1440
 FACSIMILE: (236) 422-1438

PRE-SHOW STORAGE & MATERIALS HANDLING ORDER FORM & INVOICE



DIRECT TO SHOW SHIPMENTS OF ANY EXHIBIT MATERIAL ARE NOT PERMITTED AND WILL BE REFUSED

All exhibit materials must be sent to the advanced receiving warehouse using the attached shipping label. We will receive your exhibit materials beginning February 5. Shipments received after February 17 will not be eligible for pre-show discounts. Please ensure that your exhibit materials arrive no later than February 21 to avoid any potential delays and off target designation.

SERVICE INCLUDES;

- Receiving and advance storage of your display material beginning February 5.
- Delivery of your display material to show site and placement of material, crates and boxes directly in your booth (subject to facility freight elevator & entry door sizes)
- Removal and storage of empty boxes and crates during show.
- Return of all empty boxes and crates to your booth following close of show and re-loading of display material on to outbound carrier(s) from show site.

CRATED: Exhibit material that is skidded or is in any type of shipping crate that can be unloaded with a forklift at dock height with no additional handling required. All dimensions of each piece must be less than 55".

SPECIAL HANDLING: Exhibit material delivered in such a manner that it requires additional handling such as ground level unloading, stacked or constricted space unloading, designated piece unloading, loads mixed with carpet and / or pad wrapped material, multiple shipments, pad only shipments and shipments that require additional time, equipment or labor to unload. FEDEX, UPS, Purolator, DHL and all van lines are included in this category due to their delivery procedures. Crated or skidded material with any one dimension 55" or greater.

SMALL PACKAGE SHIPMENT: Shipment that consists of 1 piece with a total weight not exceeding 20#. Canada Post shipments not included.

OVERTIME: Any shipment that is moved in to (inbound) or out of (outbound) the exhibit hall between 5:00 PM and 8:00 AM, Monday to Friday, all day Saturday, all day Sunday and all holidays. These hours will differ from exhibitor move-in hours, accounting for facility access, elevator availability, etc.

OFF TARGET SHIPMENT: Any shipment that is recieved prior to February 5 or after February 21, 2025.

SERVICE DESCRIPTION	PRE-DEADLINE	POST DEADLINE	MINIMUM CHARGES	
Crated or Skidded Shipment	\$ 1.00 / Pound	\$ 1.40 / Pound	\$ 300.00 (Pre-Deadline)	\$ 420.00 (Post Deadline)
Special Handling Shipment	\$ 1.40 / Pound	\$ 1.70 / Pound	\$ 300.00 (Pre Deadline)	\$ 420.00 (Post Deadline)
Small Package Shipment	\$ 85.00 Total	\$ 115.00 Total	\$ 85.00 (Pre Deadline)	\$ 115.00 (Post Deadline)
Overtime Charge	\$.35 / Pound	\$.49 / Pound	\$ 50.00 (Pre Deadline)	\$ 70.00 (Post Deadline)
Off Target Shipment	\$.30 / Pound	\$.42 / Pound	\$ 50.00 (Pre Deadline)	\$ 70.00 (Post Deadline)

When recording weight you must round up to the next one hundred (100) pounds. Example 445 lbs = 500 lbs.

Shipments arriving from different carriers and / or on different dates and times and / or on different waybills or tracking numbers will be billed individually.

Dimensional weight will be charged on all shipments exceeding 25 cubic feet(43,200 cu. in.).

Dimensional weight is calculated as follows: L x W x H / 1728 x 10

			TOTAL WEIGHT	
MATERIAL SHIPPED FROM (CITY)		DATE SHIPPED	SUB TOTAL	
# OF BOXES	# OF CRATES OR SKIDS	TOTAL # OF PIECES	20 % SERVICE CHARGE	
CARRIER		PRO OR WAYBILL NUMBER	SUB-TOTAL	
CUSTOMS BROKER (IF APPLICABLE)			7 % PST	
<div style="border: 1px solid black; padding: 5px;"> I AGREE THAT IN PLACING THIS ORDER I HAVE READ AND ACCEPT SHOW IN MOTIONS' PAYMENT POLICY AND TERMS & CONDITIONS OF CONTRACT. </div>			5 % GST	
			TOTAL	

All orders governed by Show In Motion Payment Policy and Terms & Conditions as specified in this service manual.

COMPANY: _____ BOOTH #: _____

AUTHORIZED BY: _____ AUTHORIZED SIGNATURE: _____

STANDARD RATES WILL BE APPLIED TO ALL ORDERS RECEIVED AFTER 4:00 PM PACIFIC TIME ON: FEBRUARY 4, 2025

YOUR COMPLETED CREDIT CARD AUTHORIZATION FORM MUST ACCOMPANY THIS ORDER FORM.

ALL ORDERS ARE GOVERNED BY SHOW IN MOTION PAYMENT POLICY AND TERMS AND CONDITIONS OF CONTRACT.



TELEPHONE: (236) 422-1440
 FACSIMILE: (236) 422-1438

**PRIORITY EMPTY RETURN
 SERVICE ORDER FORM
 AND INVOICE**



Depending on the size of the show and the logistics of the facility, the standard return time for crates, containers and cases can be anywhere from 1 - 3 hours.

This service provides for the expedited Priority Return of your empty containers.

Exhibitors ordering this service can expect their crates and other empties returned to their booth within 15 minutes of the close of show.

This service must be ordered prior to your empty containers being removed from the exhibit floor and entered in to storage.

If you would like to take advantage of this service, please complete the information below and return this form to Show In Motion.

RATES	PRICE PER CONTAINER	PRICE PER CONTAINER
	Discount Rate	Standard Rate
Priority Empty Container Return	\$ 85.00	\$ 119.00
Estimated Number of Pieces..... _____		
PLEASE NOTE THAT THIS SERVICE CANNOT BE ORDERED ONCE YOUR EMPTY CONTAINERS HAVE BEEN REMOVED FROM THE EXHIBIT HALL FOR STORAGE.	SUB-TOTAL	
	20 % SERVICE CHARGE	
	7 % PST	
	5 % GST	
	TOTAL	

All orders governed by Show In Motion Payment Policy and Terms & Conditions as specified in this service manual.

COMPANY: _____ **BOOTH #:** _____
AUTHORIZED BY: _____ **AUTHORIZED SIGNATURE:** _____

**STANDARD RATES WILL BE APPLIED
 TO ALL ORDERS RECEIVED AFTER
 4:00 PM PACIFIC TIME ON:
 FEBRUARY 4, 2025**

**YOUR COMPLETED CREDIT
 CARD AUTHORIZATION FORM
 MUST ACCOMPANY THIS
 ORDER FORM.**

**POST SHOW MATERIALS
HANDLING & STORAGE
ORDER FORM & INVOICE**



In accordance with the exhibit handling and storage policies of both the facility and the regulations of this event, all exhibit materials must be removed from the show floor no later than 8:00 PM on Thursday, February 27 to avoid forced freight designation.

If these policies are inconvenient for you and / or your carrier we are pleased to offer you the option of having your exhibit material returned to our warehouse to await pick-up from your carrier at a convenient time during normal business hours.

If you would like to order this service please complete the required information below and return this form to Show In Motion along with your other service request forms.

This service is offered in conjunction with our standard Materials Handling Service. You must complete and return the attached Materials Handling Order Form as well.

SERVICE RATES

\$.80 / Pound - Discount Rate
\$ 1.15 / Pound - Standard Rate
\$ 300 Minimum Discount Rate Charge
\$ 420 Minimum Standard Rate Charge
20% Fuel Surcharge
Rates Based on Billable Incoming Weight

PICK-UP INFORMATION

ADDRESS: # 21 - 8528 - 123 STREET
SURREY, BC, V3W 3V6
HOURS: 9:00 AM - 2:00 PM (PACIFIC TIME)
MONDAY - FRIDAY

PLEASE NOTE THAT YOU MUST MAKE PICK-UP ARRANGEMENTS WITH YOUR CARRIER. DUE TO COMMON CARRIER POLICIES AND PROCEDURES, WE ARE UNABLE TO DO THIS ON YOUR BEHALF.

PLEASE ENSURE THAT YOUR COMPLETED WAYBILL OR BILL OF LADING IS LEFT IN YOUR BOOTH WITH YOUR OUTBOUND SHIPMENT OR IS EMAILED TO BRIAN@SHOWINMOTION.COM

PLEASE NOTE THAT EXHIBIT MATERIAL REMAINING ON SITE BEYOND THE DESIGNATED MOVE-OUT TIME WILL BE FORCED TO OUR WAREHOUSE AT THE ABOVE PREVAILING RATES.

ESTIMATED WEIGHT	
ESTIMATED SUB-TOTAL	
20 % FSC	
20% SERVICE CHARGE	
7 % PST	
5 % GST	
TOTAL	

All orders governed by Show In Motion Payment Policy and Terms & Conditions as specified in this service manual.

COMPANY: _____ BOOTH #: _____
AUTHORIZED BY: _____ AUTHORIZED SIGNATURE: _____

STANDARD RATES WILL BE APPLIED TO ALL ORDERS RECEIVED AFTER 4:00 PM PACIFIC TIME ON: FEBRUARY 4, 2025

YOUR COMPLETED CREDIT CARD AUTHORIZATION FORM MUST ACCOMPANY THIS ORDER FORM.



TELEPHONE: (236) 422-1440
 FACSIMILE: (236) 422-1438

**BOOTH CLEANING SERVICES
 ORDER FORM
 AND INVOICE**



As the official service contractor, Show In Motion has exclusive jurisdiction over all cleaning services. This jurisdiction prohibits other service contractors, including exhibitor appointed contractors, from providing these services.

The cleaning services provided by the exhibit hall include a general sweeping of the aisles only.

All carpets ordered from Show In Motion will be installed in clean condition, however you may wish to order cleaning service prior to show opening to remove any debris caused during set-up.

Our standard booth cleaning service includes daily vacuuming of carpet, emptying of all waste baskets and a general cleaning and dusting of exhibit and furnishings.

Our Porter Service includes emptying of all waste baskets, wipe down of counters and removal of glasses and coffee cups at 2 hour intervals.

Booth Cleaning and porter services are not offered for partial or select days. If you are ordering these services you must order them for all days of your event.

100 square foot minimum charge.

<u>STANDARD BOOTH CLEANING</u>	DISCOUNT RATE	STANDARD RATE	AMOUNT
TOTAL SQUARE FEET _____ X NUMBER OF DAYS _____ X RATE	\$.50	\$.65	
<u>BOOTH CLEANING FIRST DAY ONLY</u>			
TOTAL SQUARE FEET _____ X 1 DAY X RATE	\$.50	\$.65	
<u>PORTER SERVICE</u>			
TOTAL SQUARE FEET _____ X NUMBER OF DAYS _____ X RATE	\$ 1.00	\$ 1.30	
SUB-TOTAL			
20 % SERVICE CHARGE			
7 % PST			
5 % GST			
TOTAL			

All orders governed by Show In Motion Payment Policy and Terms & Conditions as specified in this service manual.

COMPANY: _____ BOOTH #: _____
 AUTHORIZED BY: _____ AUTHORIZED SIGNATURE: _____

**STANDARD RATES WILL BE APPLIED
 TO ALL ORDERS RECEIVED AFTER
 4:00 PM PACIFIC TIME ON:
 FEBRUARY 4, 2025**

**YOUR COMPLETED CREDIT
 CARD AUTHORIZATION FORM
 MUST ACCOMPANY THIS
 ORDER FORM.**



TELEPHONE: (236) 422-1440
 FACSIMILE: (236) 422-1438

**TOUCHSCREEN KIOSK
 LEASE ORDER FORM
 AND INVOICE**



RATES	DISCOUNT	STANDARD	AMOUNT
DURATION OF EVENT	\$ 650	\$ 845	
OPTIONAL BRANDING WITH YOUR CUSTOM LOGOS & TEXT			
ABOVE MONITOR	\$ 150	\$ 195	
BELOW MONITOR	\$ 100	\$ 130	
BELOW KEYBOARD	\$ 200	\$ 260	
		SUB-TOTAL	
		20 % SERVICE CHARGE	
		7 % PST	
		5 % GST	
		TOTAL	

All orders governed by Show In Motion Payment Policy and Terms & Conditions as specified in this service manual.

COMPANY: _____ BOOTH #: _____
 AUTHORIZED BY: _____ AUTHORIZED SIGNATURE: _____

**STANDARD RATES WILL BE APPLIED
 TO ALL ORDERS RECEIVED AFTER
 4:00 PM PACIFIC TIME ON:
 FEBRUARY 4, 2025**

**YOUR COMPLETED CREDIT
 CARD AUTHORIZATION FORM
 MUST ACCOMPANY THIS
 ORDER FORM.**



TELEPHONE: (236) 422-1440
 FACSIMILE: (236) 422-1438

**COMPUTER & A/V
 LEASE ORDER FORM
 AND INVOICE**



ITEM	PRICE	PRICE	QUANTITY	AMOUNT
	Discount Rate Daily Rate	Standard Rate Daily Rate		
MONITORS				
32" 4K UHD Includes Table Top base	180.00	250.00		
42" 4K UHD LED LCD Includes Table Top Base	350.00	490.00		
55" 4K UHD QLED LCD Includes Table Top Base	600.00	840.00		
70" 4K UHD QLED LCD Includes Table Top Base	725.00	990.00		
MISCELLANEOUS				
Touch Screen Kiosk (Custom Graphics Package Available)	450.00	630.00		
40" Charging Station (Custom Graphics Package Available)	350.00	490.00		
Monitor Floor Stand (Dual Post)	75.00	105.00		
BOSE S1 Pro Portable Bluetooth Speaker	150.00	210.00		
Black Skirted A/V Cart	50.00	70.00		
Triple Head Extension Cord	30.00	42.00		
Surge Protected Power Bar	30.00	42.00		
COMPUTER SYSTEMS (MONITOR NOT INCLUDED)				
Lenovo ThinkPad 15.6" 4K UHD Intel Core i7 512 GB SSD	400.00	560.00		
MacBook Pro 14" - Apple M1 Pro Chip 16GB TB SSD	400.00	560.00		
PRINTERS				
HP LaserJet Pro Black & White, 1200 dpi, 42 ppm, 512 Ram	180.00	250.00		
HP Color LaserJet Pro MFP, 40ppm, 1200, 1GB Ram	240.00	336.00		
Premium Laser Printer Paper (500 sheets)	20.00	28.00		
BASIC INSTALLATION LABOR				\$ 50.00
SUB-TOTAL				
20 % SERVICE CHARGE				
7 % PST				
5 % GST				
TOTAL				

Custom Audio and Visual Packages Available on Request.

Please Call Us For Further Details.



All orders governed by Show In Motion Payment Policy and Terms & Conditions as specified in this service manual.

COMPANY: _____ BOOTH #: _____
 AUTHORIZED BY: _____ AUTHORIZED SIGNATURE: _____

**STANDARD RATES WILL BE APPLIED
 TO ALL ORDERS RECEIVED AFTER
 4:00 PM PACIFIC TIME ON:
 FEBRUARY 4, 2025**

**YOUR COMPLETED CREDIT
 CARD AUTHORIZATION FORM
 MUST ACCOMPANY THIS
 ORDER FORM.**



TELEPHONE: (236) 422-1440
 FACSIMILE: (236) 422-1438

**CARPET & PADDING
 LEASE ORDER FORM
 AND INVOICE**



32 OZ. DESIGNER SELECT CARPET

Guaranteed new, premium quality carpet.
 Available in a variety of designer colors.

- Black Pewter Charcoal
 Navy Silver Royal Blue
 Red Emerald Purple

Booth Size: _____' x _____' = _____ Square Feet

PRICE Discount Rate	PRICE Standard Rate	QUANTITY	AMOUNT
\$ 3.00 (Sq. Ft.)	\$ 4.20 (Sq. Ft.)		

20 OZ. STANDARD CARPET

Available in 4 standard colors.

- Blue Forest Green
 Red Purple

Booth Size: _____' x _____' = _____ Square Feet

PRICE Discount Rate	PRICE Standard Rate	QUANTITY	AMOUNT
\$ 2.25 (Sq. Ft.)	\$ 3.15 (Sq. Ft.)		

LAMINATE PLANK FLOORING

Available in 4 standard colors.

- Dark Maple Dark Oak
 Light Maple Washed Gray

Booth Size: _____' x _____' = _____ Square Feet

PRICE Discount Rate	PRICE Standard Rate	QUANTITY	AMOUNT
\$ 7.25 (Sq. Ft.)	\$ 9.50 (Sq. Ft.)		

5/8" REBOND FOAM PADDING

Booth Size: _____' x _____' = _____ Square Feet

PRICE Discount Rate	PRICE Standard Rate	QUANTITY	AMOUNT
\$ 2.00 (Sq. Ft.)	\$ 2.80 (Sq. Ft.)		

VISQUEEN PLASTIC COVERING

Booth Size: _____' x _____' = _____ Square Feet

PRICE Discount Rate	PRICE Standard Rate	QUANTITY	AMOUNT
\$ 1.00 (Sq. Ft.)	\$ 1.40 (Sq. Ft.)		

**100 SQUARE FOOT MINIMUM ON ALL ORDERS
 OTHER SIZES IN 10' X 10' INCREMENTS ONLY
 ALL PRICES INCLUDE INSTALLATION & TAPING
 AND INITIAL VACUUMING
 SURCHARGES FOR ANY DAMAGE AFTER INSTALLATION**

SUB-TOTAL	
20 % SERVICE CHARGE	
7 % PST	
5 % GST	
TOTAL	

NO ORDERS WILL BE PROCESSED UNTIL PAYMENT IS MADE IN FULL

All orders governed by Show In Motion Payment Policy and Terms & Conditions as specified in this service manual.

COMPANY: _____ BOOTH #: _____

AUTHORIZED BY: _____ AUTHORIZED SIGNATURE: _____

**STANDARD RATES WILL BE APPLIED
 TO ALL ORDERS RECEIVED AFTER
 4:00 PM PACIFIC TIME ON:
 FEBRUARY 4, 2025**

**YOUR COMPLETED CREDIT
 CARD AUTHORIZATION FORM
 MUST ACCOMPANY THIS
 ORDER FORM.**



TELEPHONE: (236) 422-1440
 FACSIMILE: (236) 422-1438

**TABLES & CHAIRS
 LEASE ORDER FORM
 AND INVOICE**



DISPLAY ITEMS	PRICE		QUANTITY	AMOUNT
	Discount Rate	Standard Rate		
TABLES & RISERS				
Covered & Skirted Display Table (2' X 4')	\$ 100.00	\$ 140.00		
Covered & Skirted Display Table (2' X 6')	100.00	140.00		
Covered & Skirted Display Table (2' X 8')	110.00	152.00		
4th. Side Of Table Skirted	50.00	70.00		
Extension To 40" Height - Add	50.00	70.00		
Unskirted Display Table	100.00	140.00		
Blue, Teal, Green, Red, Black, Silver, Purple, Gold or White (Circle Preference)				
30" High Pedestal Table with Spandex - Black or White	155.00	215.00		
40" High Pedestal Table with Spandex - Black or White	155.00	215.00		
STOOLS AND CHAIRS				
White Crescent Stool	200.00	280.00		
High Back Bar Stool	150.00	210.00		
White Mobler Stool	160.00	224.00		
Wood & Chrome Stool	110.00	154.00		
Black & Silver Bar Stool	150.00	210.00		
Deluxe High Back Bar Stool	150.00	210.00		
White & Chrome Wire Back Stool	160.00	224.00		
Deluxe Executive Armchair (Black Leather Sled Base)	120.00	168.00		
High Back Swivel Stool (Black or Silver)	100.00	140.00		
Upholstered Arm Chair (Black Fabric)	60.00	84.00		
Upholstered Side Chair (No Arms)	50.00	70.00		
COMPLIMENTS (See Accessories Sheet Also)				
8' High Drapery (Color Preference: _____)	10.00 / FT.	14.00 / FT.		
Plexi Glass Ballot	50.00	70.00		
Tripod Easel	50.00	70.00		
Waste Paper Basket (Black Wire Mesh)	25.00	35.00		
SUB-TOTAL				
20 % SERVICE CHARGE				
7 % PST				
5 % GST				
TOTAL				



All orders governed by Show In Motion Payment Policy and Terms & Conditions as specified in this service manual.

COMPANY: _____ BOOTH #: _____
 AUTHORIZED BY: _____ AUTHORIZED SIGNATURE: _____

**STANDARD RATES WILL BE APPLIED
 TO ALL ORDERS RECEIVED AFTER
 4:00 PM PACIFIC TIME ON:
 FEBRUARY 4, 2025**

**YOUR COMPLETED CREDIT
 CARD AUTHORIZATION FORM
 MUST ACCOMPANY THIS
 ORDER FORM.**

**SPECIALTY
FURNITURE**



White Crescent Stool



White & Chrome
Wire Back Stool

White Mobler Stool



High Back Bar Stool

Black and Silver Stool



Deluxe High Back Stool



Wood and Chrome Stool



Brushed Steel & Glass Top
Bistro Table



White Geo Coffee Table



Black Geo Coffee Table



24" Square Table
White Top



24" Round Table
White Top

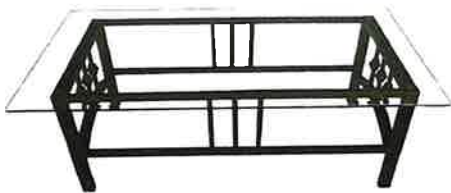

Gun Metal Coffee Table - Smoked Top



Gun Metal End Table
Smoked Top



Round Coffee Table



Black Geo End Table



TELEPHONE: (236) 422-1440
 FACSIMILE: (236) 422-1438

**SPECIALTY FURNITURE
 SOFT SEATING
 LEASE ORDER FORM & INVOICE**



ITEM	PRICE		QUANTITY	AMOUNT
	Discount Rate	Standard Rate		
White Crescent Leather Stool	200.00	280.00		
White Leather & Chrome Wire Back Stool	150.00	210.00		
White Leather Mobler Stool	160.00	224.00		
Black High Back Bar Stool	150.00	210.00		
Black & Silver High Back Bar Stool	150.00	210.00		
Black Leather Deluxe High Back Stool	150.00	210.00		
Wood & Chrome Bar Stool	110.00	154.00		
Brushed Steel & Glass Top Bistro Table	300.00	420.00		
White Geo Coffee Table	160.00	224.00		
Black Geo Coffee Table	160.00	224.00		
24" Square Bistro Table - White Top	160.00	224.00		
24" Round Bistro Table - White Top	160.00	224.00		
32" Round Coffee Table - Black Top	175.00	245.00		
32" Round Coffee Table - White Top	175.00	245.00		
39" Round Coffee Table - Black Top	200.00	280.00		
39" Round Coffee Table - White Top	200.00	280.00		
Gun Metal & Smoked Glass Coffee Table	150.00	210.00		
Gun Metal & Smoked Glass End Table	150.00	210.00		
Black Geo End Table	150.00	210.00		
Chrome Bar with White Plexi Panels (30" x 42" x 72")	300.00	390.00		
Barn Door Bar (72" x 42" x 30")	600.00	780.00		
Bar Sized Refrigerator (4.5 cubic feet)	200.00	260.00		
Old Fashioned Style Popcorn Machine	250.00	325.00		
SUB-TOTAL				
20 % SERVICE CHARGE				
7 % PST				
5 % GST				
TOTAL				

**PHOTOS OF ALL ITEMS ARE AVAILABLE AT
www.showinmotion.com**



All orders governed by Show In Motion Payment Policy and Terms & Conditions as specified in this service manual.

COMPANY: _____ BOOTH #: _____
 AUTHORIZED BY: _____ AUTHORIZED SIGNATURE: _____

**STANDARD RATES WILL BE APPLIED
 TO ALL ORDERS RECEIVED AFTER
 4:00 PM PACIFIC TIME ON:
 FEBRUARY 4, 2025**

**YOUR COMPLETED CREDIT
 CARD AUTHORIZATION FORM
 MUST ACCOMPANY THIS
 ORDER FORM.**



TELEPHONE: (236) 422-1440
FACSIMILE: (236) 422-1438

**SPECIALTY FURNITURE
SOFT SEATING**



Vancouver Sofa
80" x 28" x 29"



Vancouver Sofa
80" x 28" x 29"



Yaletown Sofa
71" x 21" x 29"



Vancouver Love Seat
57" x 28" x 28"



Vancouver Love Seat
57" x 28" x 28"



Yaletown Love Seat
57" x 21" x 29"



Vancouver Club Chair
33" x 28" x 29"



Vancouver Club Chair
33" x 28" x 29"



Yaletown Single Chair
21" x 29" x 28"



Yaletown Sofa
71" x 21" x 29"



Yaletown Love Seat
57" x 21" x 29"



Yaletown Single Chair
21" x 29" x 28"

Prices for all items shown are detailed on the Specialty Furniture and Tables & Chairs Lease Order Forms.



TELEPHONE: (236) 422-1440
FACSIMILE: (236) 422-1438

**SPECIALTY FURNITURE
SOFT SEATING**

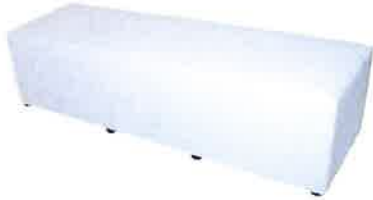

Contemporary Bench
72" x 18" x 20"



Contemporary Bench
72" x 18" x 20"



White Curved Bench
72" x 18" x 18"



Sectional Ottoman
29" x 18" x 29"



Sectional Ottoman
29" x 16" x 29"



Round Back Tub Chair
28" x 27" x 28"



Contemporary Cube
18" x 18" x 18"



Contemporary Cube
18" x 18" x 18"

Prices for all items shown are detailed on the Specialty Furniture and Tables & Chairs Lease Order Forms.



TELEPHONE: (236) 422-1440
 FACSIMILE: (236) 422-1438

**SPECIALTY FURNITURE
 SOFT SEATING
 ORDER FORM & INVOICE**



ITEM	PRICE	PRICE	QUANTITY	AMOUNT
	Discount Rate	Standard Rate		
Vancouver Sofa - Black	400.00	560.00		
Vancouver Sofa - White	400.00	560.00		
Vancouver Love Seat - Black	350.00	490.00		
Vancouver Love Seat - White	350.00	490.00		
Vancouver Club Chair - Black	300.00	420.00		
Vancouver Club Chair - White	300.00	420.00		
Yaletown Sofa - Black	450.00	630.00		
Yaletown Sofa - White	450.00	630.00		
Yaletown Love Seat - Black	400.00	560.00		
Yaletown Love Seat - White	400.00	560.00		
Yaletown Single Chair - Black	300.00	420.00		
Yaletown Single Chair - White	300.00	420.00		
Overstuffed Leather Sofa - Black	350.00	490.00		
Overstuffed Leather Love Seat - Black	300.00	420.00		
Overstuffed Leather Club Chair - Black	250.00	350.00		
Contemporary Bench - Black	200.00	280.00		
Contemporary Bench - White	200.00	280.00		
Curved Bench - White	250.00	350.00		
Sectional Ottoman - Black	350.00	490.00		
Sectional Ottoman - White	350.00	490.00		
Round Back Tub Chair - White	250.00	350.00		
Contemporary Cube - Black	120.00	170.00		
Contemporary Cube - White	120.00	170.00		
SUB-TOTAL				
20 % SERVICE CHARGE				
7 % PST				
5 % GST				
TOTAL				

**PHOTOS OF ALL ITEMS ARE AVAILABLE AT
www.showinmotion.com**



All orders governed by Show In Motion Payment Policy and Terms & Conditions as specified in this service manual.

COMPANY: _____ BOOTH #: _____

AUTHORIZED BY: _____ AUTHORIZED SIGNATURE: _____

**STANDARD RATES WILL BE APPLIED
 TO ALL ORDERS RECEIVED AFTER
 4:00 PM PACIFIC TIME ON:
 FEBRUARY 4, 2025**

**YOUR COMPLETED CREDIT
 CARD AUTHORIZATION FORM
 MUST ACCOMPANY THIS
 ORDER FORM.**

**STANDARD DISPLAY
FURNISHINGS**

Black Counter
40" x 40" x 20"



White Counter
40" x 40" x 20"

Computer Counter
20" x 20" x 40"



Chrome Sign Holder



Pedestal Table
Black Fitted Spandex



Upholstered Arm Chair



Upholstered Side Chair



Waste Paper Basket



Literature Rack

Bag Holder



Deluxe Executive
Arm Chair

Ballot Box











Brass Ballot Drum

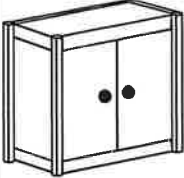
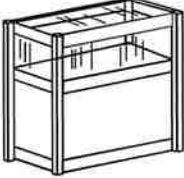
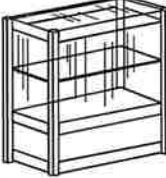
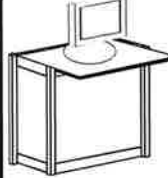
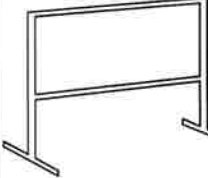

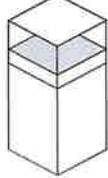
TELEPHONE: (236) 422-1440
 FACSIMILE: (236) 422-1438

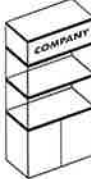
**CUSTOM ACCESSORIES
 LEASE ORDER FORM
 AND INVOICE**

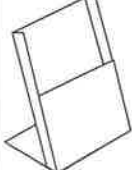

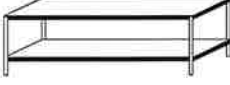
<p>COUNTER \$ 420 SLIDING DOORS INSIDE SHELF 20" X 40" X 40" <input type="checkbox"/> LOCK ADD \$ 25.00 <input type="checkbox"/> WHITE OR <input type="checkbox"/> BLACK</p> 	QTY:	<p>JEWELLERY CASE \$ 600 ONE SHELF 20" X 40" X 70" <input type="checkbox"/> LOCK ADD \$ 25.00 HALOGEN <input type="checkbox"/> LIGHT ADD \$ 50.00</p> 	QTY:	<p>SHOW CASE \$ 650 TWO SHELVES 20" X 40" X 70" <input type="checkbox"/> LOCK ADD \$ 25.00 HALOGEN <input type="checkbox"/> LIGHT ADD \$ 50.00</p> 	QTY:	<p>COMPUTER COUNTER \$ 400 10" KEYBOARD TRAY SLIDING DOORS INSIDE SHELF 20" X 40" X 40" <input type="checkbox"/> LOCK ADD \$ 20.00</p> 	QTY:
<p>POSTER BOARD \$ 200 4' X 8' VERTICAL OR HORIZONTAL (SHOWN)</p> 		<p>CHROME BAG HOLDER \$ 75</p> 		<p>LITERATURE RACK \$ 120 BLACK DOUBLE SIDED</p> 		<p>MONITOR STAND \$ 300 20" X 20" X 40" 20" X 20" X 54" OPTIONAL KEYBOARD TRAY AVAILABLE ADD \$ 25.00</p> 	
<p>SIGN HOLDER \$ 50 22" X 28" CHROME <input type="checkbox"/> OR BLACK <input type="checkbox"/></p> 		<p>TRACK LIGHTING 3 HEAD - \$ 120 5 HEAD - \$ 150</p> 		<p>TOWER COMBO \$ 350 2 SHELVES INSIDE SHELF 20" X 40" X 96" COMPANY NAME OR PRODUCT SIGN INCLUDED</p> 		<p>SHELF UNITS 2 SHELVES 26" \$125 3 SHELVES 40" \$150 4 SHELVES 54" \$175</p> 	
<p>BROCHURE RACK \$ 15 <input type="checkbox"/> 4" X 9" OR <input type="checkbox"/> 9" X 11" <input type="checkbox"/> COUNTER TOP <input type="checkbox"/> WALL MOUNT</p> 		<p>BAR FRIDGE \$ 175 1.7 CUBIC FEET WHITE</p> 		<p>END TABLE \$ 160 BLACK & GLASS GUN METAL & GLASS</p> 		<p>COFFEE TABLE \$ 160 BLACK & GLASS GUN METAL & GLASS</p> 	

SPECIAL INSTRUCTIONS:

SUB-TOTAL
STANDARD RATE
(ADD 40%)
20 % SERVICE
CHARGE
7 % PST
5 % GST
TOTAL

All orders governed by Show In Motion Payment Policy and Terms & Conditions as specified in this service manual.

COMPANY: _____ **BOOTH #:** _____
AUTHORIZED BY: _____ **AUTHORIZED SIGNATURE:** _____

**STANDARD RATES WILL BE APPLIED
 TO ALL ORDERS RECEIVED AFTER
 4:00 PM PACIFIC TIME ON:
 FEBRUARY 4, 2025**

**YOUR COMPLETED CREDIT
 CARD AUTHORIZATION FORM
 MUST ACCOMPANY THIS
 ORDER FORM.**



TELEPHONE: (236) 422-1440
 FACSIMILE: (236) 422-1438

**POPUP AND
 BANNER STAND
 ORDER FORM & INVOICE**



ORIENT RETRACTABLE
 BANNER STAND
 31.5" X 83" - \$ 600
 39.25" X 83" - \$ 650



PACIFIC RETRACTABLE
 BANNER STAND
 31.5" X 83" - \$ 600

COYOTE POP-UP DISPLAY
 WITH 2 HALOGEN LIGHTS
 97" W x 87.5" H
 WITH YOUR FULL
 COLOR DIGITAL GRAPHICS
 \$ 3,200
 WITH BLACK VELCRO PANELS
 \$ 2,000
 OPTIONAL COUNTER WITH YOUR
 FULL COLOR DIGITAL GRAPHICS - \$ 700



HOP-UP
 DISPLAY WALL
 WITH 2 HALOGEN LIGHTS
 WITH YOUR FULL
 COLOR DIGITAL GRAPHICS
 118" W x 89.5" H
 \$ 3,500

BANNER STAND OR POP UP DESCRIPTION	DISCOUNT RATE	STANDARD RATE		
ORIENT BANNER STAND WITH YOUR FULL COLOR GRAPHIC PANELS - 31.5" X 83"	\$ 700	\$ 980		
ORIENT BANNER STAND WITH YOUR FULL COLOR GRAPHIC PANELS - 39.25" X 83"	\$ 750	\$ 1050	SUB-TOTAL	
PACIFIC BANNER STAND WITH YOUR FULL COLOR GRAPHIC PANELS - 31.5" X 83"	\$ 750	\$ 1050	20 % SERVICE CHARGE	
COYOTE POPUP DISPLAY WITH FULL COLOR GRAPHIC PANELS	\$ 3200	\$ 4480		
COYOTE POPUP DISPLAY WITH BLACK VELCRO PANELS	\$ 2000	\$ 2800	7 % PST	
OPTIONAL COUNTER WITH FULL COLOR GRAPHIC PANEL	\$ 700	\$ 980	5 % GST	
HOP-UP FABRIC BACKWALL DISPLAY WITH YOUR FULL COLOR DIGITAL GRAPHICS	\$ 3500	\$ 4900	TOTAL	

ARTWORK REQUIRED;

Acceptable File Formats: PDF, Adobe Illustrator AI, EPS
 All fonts must be converted to outlines, curves or paths
 All photos or raster / bitmap images must be a minimum of 72 dpi / ppi at the 100% final finished size.

All orders governed by Show In Motion Payment Policy and Terms & Conditions as specified in this service manual.

COMPANY: _____ BOOTH #: _____

AUTHORIZED BY: _____ AUTHORIZED SIGNATURE: _____

**STANDARD RATES WILL BE APPLIED
 TO ALL ORDERS RECEIVED AFTER
 4:00 PM PACIFIC TIME ON:
 FEBRUARY 4, 2025**

**YOUR COMPLETED CREDIT
 CARD AUTHORIZATION FORM
 MUST ACCOMPANY THIS
 ORDER FORM.**

**10' X 8' HARDWALL
SYSTEM RENTALS**

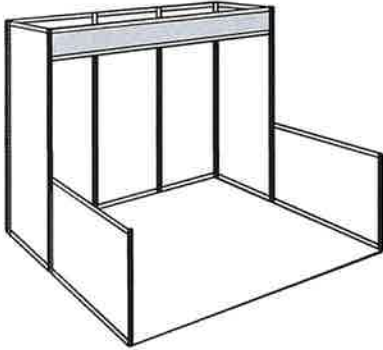

MODEL # 101

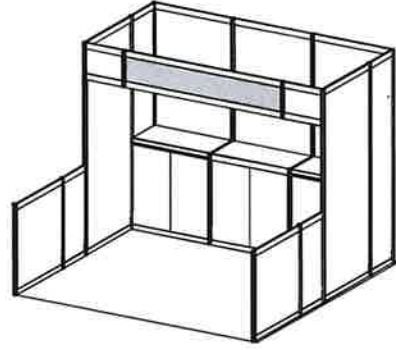

MODEL # 102

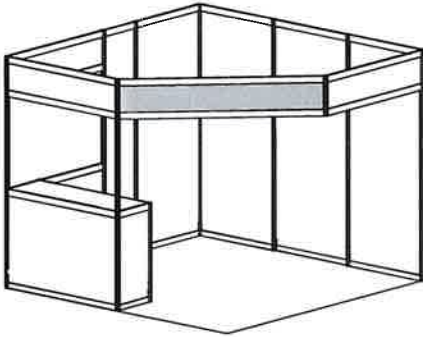

MODEL # 103

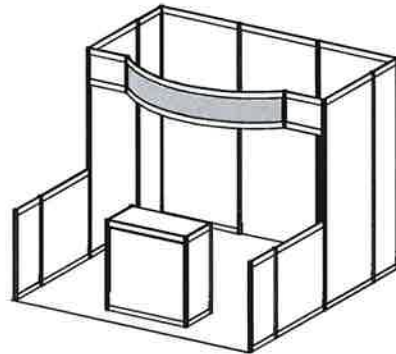

MODEL # 104

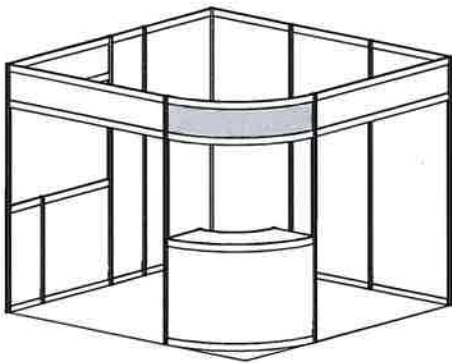

MODEL # 105

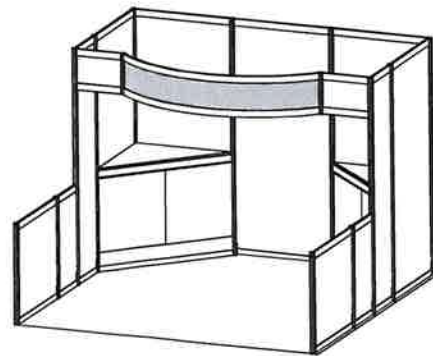

MODEL # 106

GRAY INDICATES STANDARD FASCIA SIGN

PLEASE REFER TO ATTACHED ORDER FORM FOR PRICING AND SELECTIONS

**20' X 8' HARDWALL
SYSTEMS RENTALS**

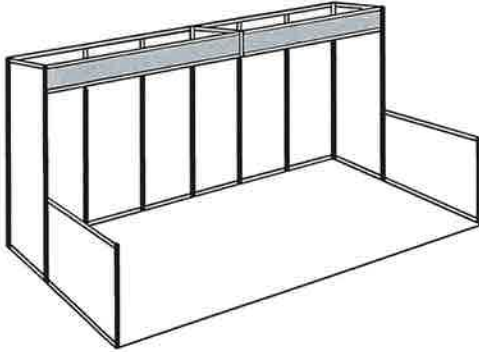

MODEL # 201

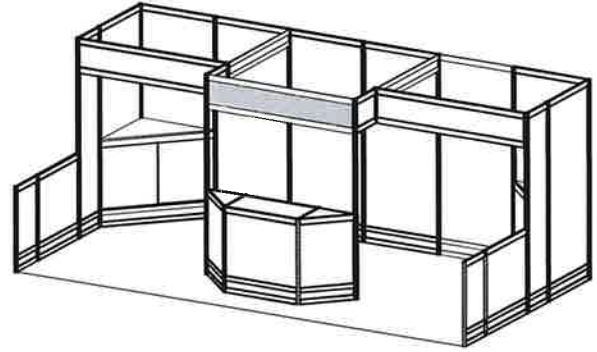

MODEL # 202

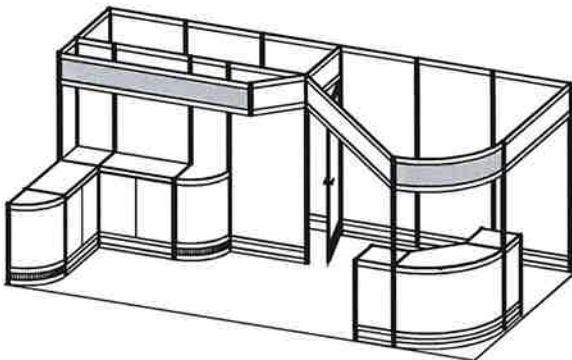

MODEL # 203

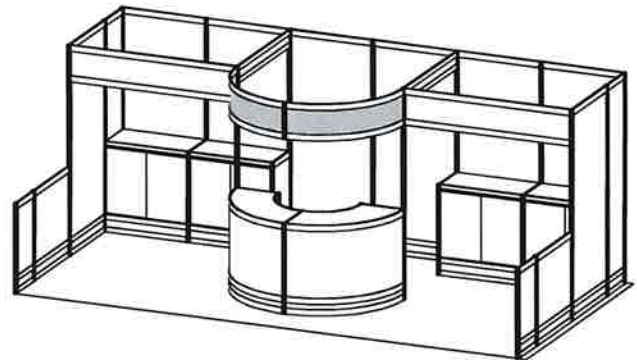

MODEL # 204

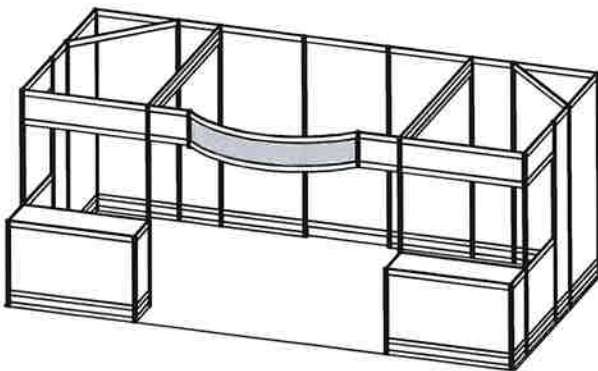

MODEL # 205

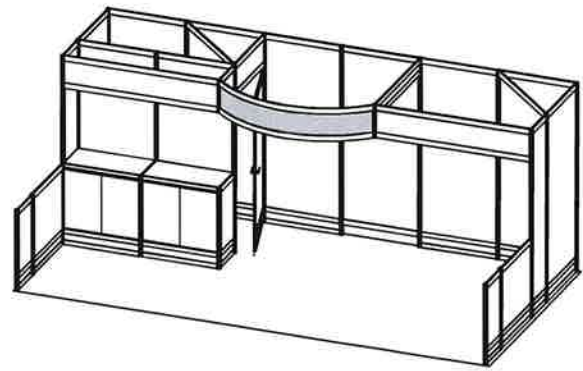

MODEL # 206

GRAY INDICATES STANDARD FASCIA SIGN(S)

PLEASE REFER TO ATTACHED ORDER FORM FOR PRICING AND SELECTIONS



TELEPHONE: (236) 422-1440
 FACSIMILE: (236) 422-1438

**HARDWALL BOOTH
 LEASE ORDER FORM
 AND INVOICE**



Packages include your choice of infill panel and carpet colors, company or product identification sign, complete installation and dismantling.

Packages do not include booth cleaning, lighting fixtures or electrical circuits.

- FONT COLOR
 BLACK BLUE RED
- INFILL PANEL COLOR
 BLACK GRAY WHITE
- CARPET COLOR
 BLUE SILVER GREEN

MODEL NUMBER	DISCOUNT RATE	STANDARD RATE	AMOUNT
MODEL # 101	\$ 1100.00	\$ 1540.00	
MODEL # 102	\$ 2325.00	\$ 3255.00	
MODEL # 103	\$ 1700.00	\$ 2380.00	
MODEL # 104	\$ 1975.00	\$ 2765.00	
MODEL # 105	\$ 1775.00	\$ 2485.00	
MODEL # 106	\$ 2425.00	\$ 3395.00	
MODEL # 201	\$ 1400.00	\$ 1960.00	
MODEL # 202	\$ 3275.00	\$ 4585.00	
MODEL # 203	\$ 4885.00	\$ 6840.00	
MODEL # 204	\$ 4350.00	\$ 6090.00	
MODEL # 205	\$ 3510.00	\$ 4914.00	
MODEL # 206	\$ 4025.00	\$ 5635.00	
— AVAILABLE OPTIONS —			
SHELF - .25M DEEP X 1.0M WIDE	\$ 75.00	\$ 105.00	
SLAT WALL PANELS - 1.0M WIDE X 2.5M HIGH	\$ 100.00	\$ 140.00	
GRID PANELS - .6M WIDE X 2.5M HIGH	\$ 75.00	\$ 105.00	

MODELS # 101,102,103, 104, 105,106, 202, 205 AND 206
 IDENTIFICATION SIGN TO READ:

MODELS # 201, 203 AND 204 IDENTIFICATION SIGN TO READ:

LEFT: _____

RIGHT: _____

SUB-TOTAL
 20 % SERVICE CHARGE
 7 % PST
 5 % GST
 TOTAL

All orders governed by Show In Motion Payment Policy and Terms & Conditions as specified in this service manual.

COMPANY: _____ BOOTH #: _____
 AUTHORIZED BY: _____ AUTHORIZED SIGNATURE: _____

**STANDARD RATES WILL BE APPLIED
 TO ALL ORDERS RECEIVED AFTER
 4:00 PM PACIFIC TIME ON:
 FEBRUARY 4, 2025**

**YOUR COMPLETED CREDIT
 CARD AUTHORIZATION FORM
 MUST ACCOMPANY THIS
 ORDER FORM.**



TELEPHONE: (236) 422-1440
FACSIMILE: (236) 422-1438

**SKILLED LABOUR
EXHIBIT INSTALLATION
ORDER FORM & INVOICE**



	TIME REQUIRED	DISCOUNT RATE	STANDARD RATE
REGULAR TIME	8:00 A.M. - 4:00 P.M. - WEEKDAYS	\$ 85.00 / HR.	\$ 115.00 / HR.
OVERTIME	4:00 P.M. - 6:00 P.M. - WEEKDAYS 8:00 A.M. - 4:00 P.M. - SATURDAYS	\$ 95.00 / HR.	\$ 133.00 / HR.
DOUBLE TIME	ALL OTHER HOURS INCLUDING SUNDAYS & HOLIDAYS	\$ 105.00 / HR.	\$ 147.00 / HR.
SUPERVISORY CHARGE	25% OF LABOR TOTAL	<input type="checkbox"/> REQUIRED <input type="checkbox"/> NOT REQUIRED	

INSTALLATION (ESTIMATED REQUIREMENTS):

DATE: _____ START TIME DESIRED _____

NUMBER OF MEN REQUESTED: _____ ESTIMATED NUMBER OF MAN HOURS : _____

ESTIMATED INSTALLATION CHARGES: \$ _____

DISMANTLE (ESTIMATED REQUIREMENTS):

DATE: _____ START TIME DESIRED: _____

NUMBER OF MEN REQUESTED: _____ ESTIMATED NUMBER OF MAN HOURS : _____

ESTIMATED INSTALLATION CHARGES: \$ _____

- SUPERVISORY CHARGES WILL APPLY UNLESS THERE IS A REPRESENTATIVE FROM YOUR COMPANY IN ATTENDANCE DURING BOTH INSTALLATION AND DISMANTLING.
- MINIMUM CHARGE OF 2 (TWO) HOURS PER MAN. LABOR THEREAFTER IS CHARGED IN ONE-HALF (1/2) HOUR INCREMENTS.
- ALL WORK WILL BE DONE ON REGULAR TIME WHEN POSSIBLE
- YOU MUST REPORT TO SHOW IN MOTION SERVICE DESK TO COLLECT YOUR LABOR IF EXHIBITOR SUPERVISED.

TOTAL ESTIMATED CHARGES

**25% SUPERVISION CHARGE
(\$ 35.00 Minimum)**

20 % SERVICE CHARGE

SUB-TOTAL

7 % PST

5 % GST

TOTAL

All orders governed by Show In Motion Payment Policy and Terms & Conditions as specified in this service manual.

COMPANY: _____ **BOOTH #:** _____

AUTHORIZED BY: _____ **AUTHORIZED SIGNATURE:** _____

**STANDARD RATES WILL BE APPLIED
TO ALL ORDERS RECEIVED AFTER
4:00 PM PACIFIC TIME ON:
FEBRUARY 4, 2025**

**YOUR COMPLETED CREDIT
CARD AUTHORIZATION FORM
MUST ACCOMPANY THIS
ORDER FORM.**



TELEPHONE: (236) 422-1440
FACSIMILE: (236) 422-1438

SKILLED LABOR INFORMATION AND CONTACT FORM



PLEASE COMPLETE THE FOLLOWING INFORMATION IF YOUR DISPLAY IS TO BE SET-UP AND / OR DISMANTLED BY SHOW IN MOTION AND YOU WILL NOT BE PRESENT TO SUPERVISE THE INSTALLATION AND / OR DISMANTLE.

INBOUND SHIPPING INFORMATION

CARRIER: _____ CARRIER PHONE #: _____

SHIPPED TO: WAREHOUSE _____ SHOW SITE _____ FROM (CITY/STATE): _____ DATE SHIPPED: _____

TOTAL NUMBER OF: CRATES _____ CARTONS _____ OTHER (SPECIFY): _____

SET-UP INFORMATION

SETUP PLAN / PHOTO: ATTACHED _____ SENT WITH EXHIBIT _____ IN CRATE # _____

CARPET: WITH EXHIBIT _____ RENTED FROM SHOW IN MOTION _____ COLOR _____ SIZE _____

ELECTRICAL PLACEMENT: DRAWING ATTACHED _____ WITH EXHIBIT _____ ELECTRICAL UNDER CARPET _____

COMMENTS: _____

GRAPHICS: WITH EXHIBIT _____ SHIPPED SEPERATELY _____ CARRIER _____

COMMENTS: _____

SPECIAL TOOLS / HARDWARE REQUIRED: _____

OUTBOUND SHIPPING INFORMATION:

SHIP TO: _____

METHOD: COMMON CARRIER _____ AIR FREIGHT _____ VAN LINE _____ OTHER (Specify) _____

CARRIER (If Known): _____

FREIGHT CHARGES: PREPAID _____ COLLECT _____ ACCOUNT # _____

PLEASE PROVIDE AN EMERGENCY CONTACT:

NAME: _____ PHONE # _____

COMPANY NAME: _____ BOOTH NUMBER: _____



TELEPHONE: (236) 422-1440
 FACSIMILE: (236) 422-1438

**CUSTOM GRAPHICS
 AND SIGNAGE
 ORDER FORM & INVOICE**



We are pleased to offer you custom sign services so that you can tailor your sales message to the particular audience at this event. Select one of our standard sizes or order a special size with your logo or other custom graphics. To order your graphics, please complete this order form and attach your sign copy or email an electronic file to orders@showinmotion.com.

DIGITALLY PRINTED GRAPHICS **VINYL CUT LETTER SIGNS**

Show In Motion is pleased to provide you with the finest digital graphic reproduction available. We can print full color, photo quality, high resolution in virtually any size for banners, exhibit graphics and more.

_____ L x _____ W = _____ Sq.Ft.

_____ Sq. Ft. X \$ 22.50 (Discount Rate) = \$ _____

_____ Sq. Ft. X \$ 31.50 (Standard Rate) = \$ _____

- Minimum order is 10 square feet.
- File conversion, retouching, cloning or color correction will incur additional charges.
- Double square foot for double sided graphics.
- Round Square Foot to next whole increment.

FILE INFORMATION;

Electronic File Name: _____

Application: _____

PMS Colors: _____

BACKING MATERIAL;

Coroplast Styrene Plexi Foamcore

PORTRAIT LANDSCAPE



SIZE	DISCOUNT RATE	STANDARD RATE	QUANTITY	AMOUNT
7" X 11"	\$ 50.00	\$ 70.00		
7" X 44"	\$ 65.00	\$ 91.00		
14" X 22"	\$ 75.00	\$ 105.00		
14" X 44"	\$ 90.00	\$ 126.00		
22" X 28"	\$ 125.00	\$ 175.00		
28" X 44"	\$ 200.00	\$ 280.00		
20" X 60"	\$ 220.00	\$ 300.00		

INDICATE YOUR COPY HERE:
 (Please attach additional pages if required)

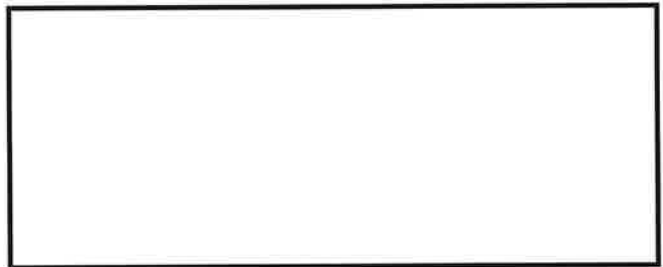

PORTRAIT LANDSCAPE



Background Color: _____

Lettering Color: _____

Font: _____

SUB-TOTAL
20 % SERVICE CHARGE
7 % PST
5 % GST
TOTAL

All orders governed by Show In Motion Payment Policy and Terms & Conditions as specified in this service manual.

COMPANY: _____ **BOOTH #:** _____

AUTHORIZED BY: _____ **AUTHORIZED SIGNATURE:** _____

**STANDARD RATES WILL BE APPLIED
 TO ALL ORDERS RECEIVED AFTER
 4:00 PM PACIFIC TIME ON:
 FEBRUARY 4, 2025**

**YOUR COMPLETED CREDIT
 CARD AUTHORIZATION FORM
 MUST ACCOMPANY THIS
 ORDER FORM.**

EXHIBITOR PAYMENT POLICY

1. **All orders for services from Show In Motion must be accompanied by a fully completed Credit Card Authorization form. NO EXCEPTIONS. We are unable to accept or process any orders that do not include a completed Credit Card Authorization form.**

2. **ELIGIBILITY FOR DISCOUNT PRICING**

To qualify for the discount pricing offered, payment in full must accompany your completed order and be received in our offices no later than 4:00 PM, Pacific time on the date shown in the bottom left corner of each order form.

3. **SHOW SITE ORDERS**

Charges for orders placed at show site by the cardholder and/or his or her representative will be charged to the credit card number on file.

4. **METHODS OF PAYMENT**

Show In Motion accepts MasterCard, Visa, American Express, Debit Card, Cheque, Interac and e-transfers. Any cheque returned to us and / or any declined credit card transaction, for any reason, will incur a service charge of \$100.00.

5. **MATERIALS HANDLING**

If you are sending exhibit materials of any size or description to this event you must complete both the Materials Handling order form and the Credit Card Authorization Form. All exhibit materials must be shipped to the address as instructed in this service manual.

SHIPMENTS DIRECT TO SHOW SITE ARE NOT PERMITTED AND WILL BE REFUSED.

Please ensure that all shipments are sent "Prepaid" including all applicable taxes, duties, surcharges, etc. Any charges billed to Show In Motion by your carrier following the event will be charged to the Credit Card number provided along with an applicable service charge.

The greater of actual weight or dimensional weight will be charged on all incoming shipments in excess of 5,000 cubic inches. Dimensional weight is calculated as follows: L x W x H / 1728 X 10.

Shipments arriving prior to receiving your completed materials handling order forms and / or not properly labeled with completed Show In Motion shipping labels will incur a minimum 20% surcharge.

Off target shipments received prior to or after the receiving dates shown on the Materials Handling order form will incur a minimum 20% surcharge to standard materials handling rates.

6. **POST EVENT STORAGE**

All exhibit materials returned to the advanced storage warehouse following the event to await pick up by the Exhibitor Appointed Carrier will incur Post Show Materials Handling charges. Storage charges will be incurred on all materials remaining in our warehouse 3 days beyond the close of show. Storage rates begin at \$ 150.00 minimum, plus applicable service charge. Materials remaining in our warehouse more than 60 days following the close of the event will be disposed of with no additional notice and at exhibitors' expense.

7. **LABOR PROVIDED UNDER SHOW IN MOTION SUPERVISION**

Show In Motion shall be responsible for the performance of labor provided under this option. Show In Motion will not be liable for loss or damage caused by delay in labor beginning work when exhibitor requests labor to begin later than the start of the working day.

8. **LABOR PROVIDED UNDER EXHIBITOR SUPERVISION**

Exhibitor shall be responsible for the performance of labor provided under this option. The exhibitor shall supervise labor secured through Show In Motion in a reasonable manner to prevent bodily injury and/or property damage. It is the exhibitors' responsibility to check in with the Show In Motion Service Desk to collect labor, and to return to Service Desk to release labor when the work is completed.

9. **SUBSTITUTIONS**

Every effort will be made to provide identical furniture items that have been ordered. If this is not possible Show In Motion reserves the right to substitute items with similar items of the same or greater quality.

10. **CANCELLATIONS**

All requests to cancel orders and for refunds must be made in writing no less than 7 full business days prior to Show In Motion's scheduled move-in. All cancellations are subject to a minimum 50% cancellation fee. Any cancellations made within 7 full business days of Show In Motion's scheduled move-in will be subject to a 100% cancellation fee.

11. **ADJUSTMENTS / CLAIM(S) FOR LOSS**

Exhibitor agrees that any and all claims for loss must be submitted to Show In Motion, in writing, immediately at show site, and in any case, no later than the conclusion of the exhibit. Exhibitor understands and agrees that all claims made after the conclusion of the exhibit will be rejected and no adjustments will be made after the close of the show.

12. All materials and equipment are supplied on a rental basis for the duration of the event and remain the property of Show In Motion.
13. It is understood and agreed that the exhibitor is responsible for the care, custody and control of all materials and equipment supplied by Show In Motion and accepts full responsibility for any loss or damage to the equipment until it is returned to Show In Motion.
14. Show In Motion "Terms and Conditions", "Payment Policy" and "Electrical Terms & Conditions" are subject to change at the sole discretion of Show In Motion and without notice to any parties.

Show In Motion Services Terms and Conditions of Contract

Show In Motion Services, Inc. Terms & Conditions and Payment Policies are subject to change at the sole discretion of Show In Motion without notice to any parties.

PLEASE READ CAREFULLY! YOU ARE ENTERING A CONTRACT WHICH MAY LIMIT YOUR POSSIBLE RECOVERIES IN CASE OF LOSS OR DAMAGE. The terms and conditions set forth below are part of the contractual agreement between SHOW IN MOTION SERVICES, INC. and you, the EXHIBITOR, who accepts the terms and conditions of this contract once any of the following conditions are met; the Credit Card Authorization form is signed; OR the Materials Handling Agreement is signed; OR the Exhibitors' materials are delivered by a carrier to either the Show In Motion warehouse, an advanced storage warehouse or a show site where Show In Motion is the official show service contractor; OR an order for any other services is placed with Show in Motion.

I. Definitions

Show In Motion: Show In Motion Services, Inc., SIM and their employees, agents, officers and related entities including, but not limited to, any sub-contractors that SIM may appoint.

Agents: SIM's agents, sub-contractors, carriers, and the agents of each.

Exhibitor: Exhibitor, including its' employees, agents, representatives, Exhibitor Appointed Contractor (EAC), or any other party requesting services from SIM. Furthermore, it is understood and agreed, that the Exhibitor is, in fact, the SHIPPER and RECEIVER, for all purposes and circumstances notwithstanding anything contained in this contract to the contrary.

Goods: Exhibits, property and commodities of any type for which SIM is requested to perform services. Show In Motion reserves the right to substitute materials with those of an equal or better variety based on availability.

Carrier: Motor carrier, van line, air carrier or air or surface freight forwarder.

Shipper: The Exhibitor, including its' employees, agents, representatives and / or EAC.

Receiver: The Exhibitor, including its' employees, agents, representatives and / or EAC.

Accessible Storage: Holding of Goods in an area from which Goods may be removed during shows.

Services: Warehousing, transportation, materials handling, unsupervised labor, supervised labor, equipment and furniture rentals and/or all related services.

Show Site: The venue or place where an exhibition or event takes place.

Supervised Labor: Labor that is provided to an Exhibitor to install or dismantle a booth or exhibit space and is supervised and/or directed by the Exhibitor.

Unsupervised Labor: Labor that is provided to an Exhibitor to install or dismantle a booth or exhibit space and pursuant to Exhibitor's election is not supervised and/or directed by SIM. Exhibitor assumes the responsibility and any liability arising therefrom, for the work of labor when Exhibitor elects to use unsupervised labor.

II. Scope

These Terms and Conditions shall be binding upon Exhibitor, SIM, and their respective Agents and representatives, including but not limited to, Exhibitor contracted labor such as EAC's and Installation and Dismantle Companies, and any other party with an interest in the Goods. Each shall have the benefit of, and be bound by, all provisions stated herein, including but not limited to, time limits and limitations of liability.

III. Customer Obligations

a. Payment for Services: Exhibitor shall be liable for all unpaid charges for services performed by SIM or agents. Exhibitor authorizes SIM to charge its' credit card directly for services rendered on Exhibitor's behalf after departure, by placing an order online, via fax, phone or through a work order on site. Payments at show site must be made via SIM-accepted credit card or electronic payment. Exhibitor acknowledges and agrees that all calculations provided by Exhibitor are estimates only and are subject to verification and correction as deemed appropriate by SIM.

b. Credit Terms: All charges are due before Services are performed unless other arrangements have been made in advance. SIM has the right to require prepayment or guarantee of the charges at the time of request for Services. A failure to pay timely will result in Exhibitor having to pay in advance for future Services. SIM retains its right to hold Exhibitor's' Goods for non-payment. If a credit card is provided to SIM, SIM is authorized to bill to such credit card any unpaid charges for Services provided to Exhibitor, including charges for return shipping. Any charges not paid within 30 days of delivery will be subject to interest at 2.0% per month until paid.

IV. Mutual Obligation Indemnification

a. Customer to SIM: Exhibitor shall defend, hold harmless and indemnify SIM from and against any claims, lawsuits, demands, liability, costs and expenses, including reasonable attorneys' fees and court costs, resulting from any injury to or death of persons, or damage to property other than Goods, relating to or arising from performance of Services herein. Exhibitor agrees to indemnify and hold SIM harmless for any and all acts of its representatives and agents, including but not limited to Exhibitor Appointed Contractors and Installation and Dismantle Companies, any subtenant or other user of its space or any agents or employees engaged in business on behalf of Exhibitor or present at Exhibitor's invitation, including supervision of labor secured through SIM. Exhibitor's obligations under this provision shall not apply to SIM's own negligence and/or willful

misconduct. EXHIBITOR ACKNOWLEDGES THAT THE SHOW SITE IS AN ACTIVE WORK ZONE AND EXHIBITOR, ITS AGENTS, EMPLOYEES AND REPRESENTATIVES ARE PRESENT AT THEIR OWN RISK.

b. SIM to Exhibitor: To the extent of SIM's own negligence and/or willful misconduct and subject to the limitations of liability below, SIM shall defend, hold harmless and indemnify Exhibitor from and against any claims, lawsuits, demands, liability, costs and expenses including reasonable attorneys' fees and court costs, resulting from any injury to or death of persons or damage to property other than Goods. SIM's obligations under this provision shall not apply to claims for bodily injury arising a) from Exhibitor's presence in areas which have been marked as "off limits to exhibitors"; and b) when exhibitors are present in the facility prior or subsequent to the effective dates or hours of Exhibitor's space lease with show management.

V. Disclaimer and Limitation of Liability

UNDER NO CIRCUMSTANCES WILL ANY PARTY BE LIABLE FOR SPECIAL, INCIDENTAL, CONSEQUENTIAL INDIRECT OR PUNITIVE DAMAGES, INCLUDING BUT NOT LIMITED TO LOSS OF PROFITS OR INCOME. SIM SHALL BE LIABLE, SUBJECT TO THE LIMITATIONS CONTAINED HEREIN, FOR LOSS OR DAMAGE TO GOODS ONLY IF SUCH LOSS OR DAMAGE IS CAUSED BY THE DIRECT NEGLIGENCE OR WILLFUL MISCONDUCT OF SIM. CLAIMS PRESENTED FOR LOSS OR DAMAGE ARISING OUT OF INCIDENTS REFERENCED IN SECTION VI HEREIN WILL BE DENIED.

VI. No Liability for Loss or Damage to Goods

- a. Condition of Goods:** SIM shall not be liable for damage, loss, or delay to uncrated freight, freight improperly packed, glass breakage or concealed damage. SIM shall not be liable for ordinary wear and tear in handling of Goods or for damage to shrink wrapped Goods. All Goods shall be able to withstand handling by heavy equipment, including but not limited to forklifts, pallet jacks, or dollies. It is the Exhibitor's responsibility to ensure that Goods are packaged correctly prior to shipment or movement on or off the Show floor.
- b. Receipt of Goods:** SIM shall not be liable for Goods received without receipts, freight bills or specified unit counts on receipts or freight bills, or for bulk shipments (i.e., courier shipments, air freight, or van lines). Such Goods shall be delivered to booth without the guarantee of piece count or condition.
- c. Force Majeure:** SIM shall not be liable for loss or damage that results from Acts of God, weather conditions, act or default of Exhibitor, shipper, or the owner of the Goods, inherent nature of the Goods, public enemy, public authority, labor disputes and acts of terrorism or war.
- d. Cold Storage:** Goods requiring cold storage are stored at Exhibitor's own risk. SIM assumes no liability or responsibility for Cold Storage.
- e. Accessible Storage:** SIM assumes no liability for loss or damage to Goods while in Accessible Storage. Storage charges are for the use of space and are not a form of insurance, or a guarantee of security.
- f. Unattended Goods:** SIM assumes no liability for loss or damage to unattended Goods received at Show Site at any time from the point of receipt of inbound Goods until the loading of the outbound Goods, including the entire term of the respective show or exhibition. Exhibitor is responsible for insuring its own Goods for any and all risk of loss.
- g. Empty Storage:** SIM assumes no liability for loss or damage to Goods or crates or the contents therein, while containers are in Empty Storage. It is Exhibitor's sole responsibility to affix the appropriate labels available at the SIM Service Desk for empty container storage and ensures that any pre-existing empty labels are removed.
- h. Forced Freight:** SIM is not liable for Exhibitor Goods left on the show floor after the show closing deadline, with or without a Material Handling Services/Straight Bill of Lading signed by Exhibitor. It is Exhibitor's responsibility to complete accurate paperwork for shipping and to ensure Exhibitor Goods are properly labeled. If Exhibitor Goods remain on the floor after the show closing deadline, SIM has the right to remove the Exhibitor Goods. SIM is authorized by Exhibitor to proceed in the manner chosen by Exhibitor on the Order for Material Handling Services/Straight Bill of Lading, if one has been completed, or otherwise to ship Exhibitor Goods at the discretion of SIM and at Exhibitor's expense. SIM shall incur no liability for such shipment. SIM retains the right to dispose of Exhibitor Goods without liability if left on the show floor unattended, without labels or not correctly labeled.
- i. Concealed Damage:** SIM shall not be liable for concealed loss or damage including but not limited to; glass, electronic equipment, prototypes, original art, uncrated Goods, or improperly packaged or labeled Goods.
- j. Unattended Booth:** Relative to inbound shipments, there may be a lapse of time between the delivery of shipment(s) to the booth by SIM or its subcontractors and the arrival of the Exhibitor's representative(s) at the booth. Similarly, relative to outgoing shipment(s), it is possible that there may be a lapse of time between the completion of packing and the actual pick up of materials from the booth for loading on to a carrier. It is understood that during such times the shipment(s) will be left in the booth unattended. Therefore, it is agreed and understood that neither SIM nor its' subcontractors shall be liable for any loss or damage occurring while the Goods are unattended in Exhibitor's booth at any time including, but not limited to, the time the Goods are delivered to the dock until the time the Goods are received by Exhibitor's chosen carrier.
- k. Hanging items from Booth:** Exhibitor shall not hang any articles, merchandise, product, advertisements, or other similar items from SIM supplied booth materials, (this includes but is not limited to Octanorm panels or pipe and drape), utilized in Exhibitor's own booth set up or in areas occupied by the show organizer or third parties. If Exhibitor does hang any prohibited items, Exhibitor alone shall be held liable for any damages, costs, actions or injuries resulting from the hanging of such item(s). SIM shall have no liability for any damages, costs, actions or injuries arising out of Exhibitor's failure to comply with this provision.

VII. Measure of Damage

- a. Sole Relief:** If found liable for any loss, SIM's sole and exclusive maximum liability for loss or damage to Exhibitor's Goods is limited to \$.30 (CAD) per pound with a maximum liability of \$100.00 (CAD) per container, or \$1,500.00 CAD) per shipment whichever is less, as agreed upon damages and exclusive remedy. Provisions of this paragraph shall apply if loss or damage, regardless of cause or origin, results directly or indirectly to property through performance of services to Exhibitor's or from negligence, active or otherwise, by SIM, its subcontractors or employees.
- b. Labor:** SIM assumes no liability for loss, damage, or bodily injury arising out of Exhibitor's supervision of SIM provided labor. If SIM supervises labor for a fee, SIM shall be liable only for actions or claims arising out of its negligent supervision. Such liability shall be limited to the cost to Exhibitor of the supervised labor or the depreciated value of the Goods, whichever is less. If Exhibitor elects to use unsupervised labor, then Exhibitor assumes all liability for the actions or claims that arise out of such work, including but not limited to loss, damage or bodily injury and shall provide SIM and show management with an indemnity, including defense costs, for any claims that result from Exhibitors' supervision or failure to supervise assigned labor.
- c.** SIM and its' subcontractors shall not be responsible for loss or damage due to fire, theft, water, vandalism acts of God, mysterious disappearance or any other causes beyond its control.
- d.** SIM and its' subcontractors shall not be responsible for loss, delay or damage due to strikes, lockouts or work stoppages of any kind.
- e.** SIM and its' subcontractors shall not be liable to any extent whatsoever for any actual, potential or assumed loss of profits or revenues, or for any other collateral costs that may result from any loss or damage to Exhibitor's materials which may it impossible or impractical to exhibit same.

VIII. Miscellaneous

- a. Insurance:** IT IS UNDERSTOOD THAT SIM IS NOT AN INSURANCE COMPANY AND DOES NOT OFFER OR PROVIDE INSURANCE. It is the obligation of Exhibitor to ensure Goods are insured from the time they leave your custody until they are returned to you following the event. Loss or theft of the Goods while in SIM storage or in transit to and from the show and/or while on the show floor is the sole responsibility of Exhibitor. SIM recommends Exhibitor arrange for All Risk Coverage.
- b. Notice of Loss or Damage:** In order to have a valid claim, notice of loss or damage to Goods must be given to SIM or its agent within 24 hours of occurrence, as evidenced in an Incident Report completed at Show Site by SIM.
- c. Filing of Claim:** Any claim for loss or damage to Goods must be submitted in writing, to SIM immediately at Show Site, and in any case, no later than the conclusion of the event. Exhibitor understands and agrees all claims after this time shall be rejected.
- d. Filing of Suit:** Any action at law regarding loss or damage to Goods must be filed within one (1) year of the date of declaration of any part of a claim.
- e. Jurisdiction:** This Agreement shall be governed by and construed in accordance with the applicable laws of Canada or, alternatively and depending on jurisdiction, the laws of the Province of British Columbia.

SPECIAL NOTE: THE CONSIGNMENT OR DELIVERY OF A SHIPMENT TO SIM OR ITS SUBCONTRACTORS BY AN EXHIBITOR OR BY A SHIPPER ON BEHALF OF THE EXHIBITOR SHALL BE CONSTRUED AS AN ACCEPTANCE BY SUCH EXHIBITOR (AND/OR OTHER SHIPPER) OF THE TERMS AND CONDITIONS SET FORTH IN THIS AGREEMENT.